













TUNING FORK CRYSTAL UNIT



NXF Series 3.0 x 9.0

  	Application : <ul style="list-style-type: none">  Typically used for real time clock application  Mobile Phone / Set-top Box  Notebook PC / Portable PC  Car navigation systems  Wireless LAN
	Features : <ul style="list-style-type: none">  Meet clock signal for tight tolerance requirement  High stability assured with tight vacuum sealing  High vibration and shock resistance  Industry standard package  RoHS compliant / Pb free

Electrical Specification :

Model	NXF 3-9
Frequency Range	3.579545 ~ 160.0 MHz
Frequency Tolerance	±10 ppm, ±20 ppm, ±30 ppm
Operating Temp Range	-10°C~ +60°C, -20°C~ +70°C
Load Capacitance	10 pF ~ 32 pF
Drive Level	10uW ~ 10uW
Shunt Capacitance	5 pF max

* Above specification subject to change without prior notice, please consult our sales representative for more information*

TAIWAN — JENJAAN QUARTEK CORPORATION

Address : 3F-5, No 504 Yun Shan Road, Chung Ho City, Taipei, Taiwan
 Tel : +886-2-8221-4498 Fax : +886-2-8221-4499
 E-mail : jenjaan@jenjaan.com.tw Web : http://www.nsk.com.tw

FACTORY - DONG GUAN ALLIED PROJECT LIMITED

Address : No. 703, Fu Min Zhong Road, Yang Yong Village, Dalang
 Town, Dong Guan, Guang Dong, China Tel : +86-769-8311-9395
 Fax : +86-769-8313-0880 E-mail : alliedj@pub.dgnet.gd.cn

TUNING FORK CRYSTAL UNIT



Equivalent Series Resistance (ESR) V.S. Frequency:

Frequency (MHz)	Oscillation Mode	NXR-11
3.57 MHz ~ 5.5 MHz	Fundamental	150Ω Max
5.6 MHz ~ 6.0 MHz	Fundamental	100Ω
6.1 MHz ~ 10.0 MHz	Fundamental	80Ω
10.1 MHz ~ 12.0 MHz	Fundamental	60Ω
12.1 MHz ~ 16.0 MHz	Fundamental	50Ω
16.1 MHz ~ 30.0 MHz	Fundamental	40Ω
26.0 MHz ~ 36.0 MHz	3 rd Overtone	100Ω
36.01 MHz ~ 64.0 MHz	3 rd Overtone	80Ω

Dimensions (mm) :

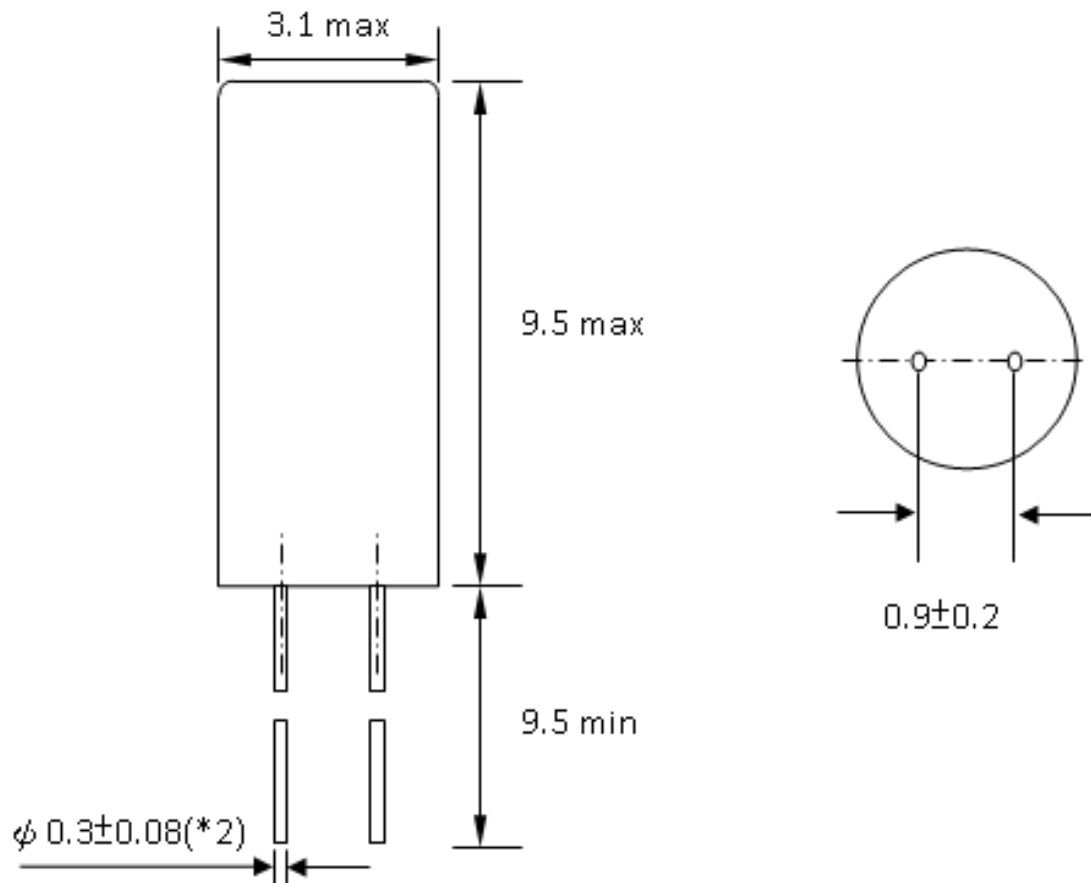

* Above specification subject to change without prior notice, please consult our sales representative for more information*

TAIWAN — JENJAAN QUARTEK CORPORATION

Address : 3F-5, No 504 Yun Shan Road, Chung Ho City, Taipei, Taiwan
 Tel : +886-2-8221-4498 Fax : +886-2-8221-4499
 E-mail : jenjaan@jenjaan.com.tw Web : http://www.nsk.com.tw

FACTORY - DONG GUAN ALLIED PROJECT LIMITED

Address : No. 703, Fu Min Zhong Road, Yang Yong Village, Dalang
 Town, Dong Guan, Guang Dong, China Tel : +86-769-8311-9395
 Fax : +86-769-8313-0880 E-mail : alliedj@pub.dgnet.gd.cn