

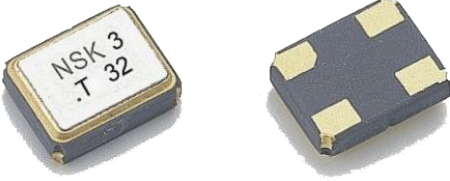













NATN Series 2.0 x 1.6

| | |
|--|--|
|    | TCXO Application : <ul style="list-style-type: none">  Communications  Smartphone  WiMAX  GPS |
| | Features : <ul style="list-style-type: none">  Excellent environmental capability  Supply voltage: 1.8V ~ 3.3V  RoHS compliant / Pb free  Low power consumption  Seam welding |



Electrical Specification :

| Model | | NATN-21 |
|-----------------------------|---------------|------------------------------|
| Frequency Range | MHz | 12.0 ~ 60.0 |
| Supply Voltage | V | 1.8 ~ 3.3 |
| Frequency Stability | PPM max | ±2.0 (After 2 times reflows) |
| Operating Temperature Range | °C | -30 ~ +85 or specify |
| Storage Temperature Range | °C | -55 ~ +125 |
| Current | mA max | 2.5 |
| Output Load | | 10KΩ // 10pF |
| Output Level | Vp-p min | 0.8 |
| Start-up Time | mS max | 5 |
| Rise and Fall Time | nS max | 5 |
| Phase Noise (10kHz offset) | dBc / Hz Typ. | -148 |
| Aging | PPM / year | ±1 |

*** Above specification subject to change without prior notice, please consult our sales representative for more information***

TAIWAN — JENJAAN QUARTEK CORPORATION

Address : 3F-5, No 504 Yun Shan Road, Chung Ho City, Taipei, Taiwan
 Tel : +886-2-8221-4498 Fax : +886-2-8221-4499
 E-mail : jenjaan@jenjaan.com.tw Web : http://www.nsk.com.tw

FACTORY - DONG GUAN ALLIED PROJECT LIMITED

Address : No. 703, Fu Min Zhong Road, Yang Yong Village, Dalang
 Town, Dong Guan, Guang Dong, China Tel : +86-769-8311-9395
 Fax : +86-769-8313-0880 E-mail : alliedj@pub.dgnet.gd.cn



Dimensions (mm) :

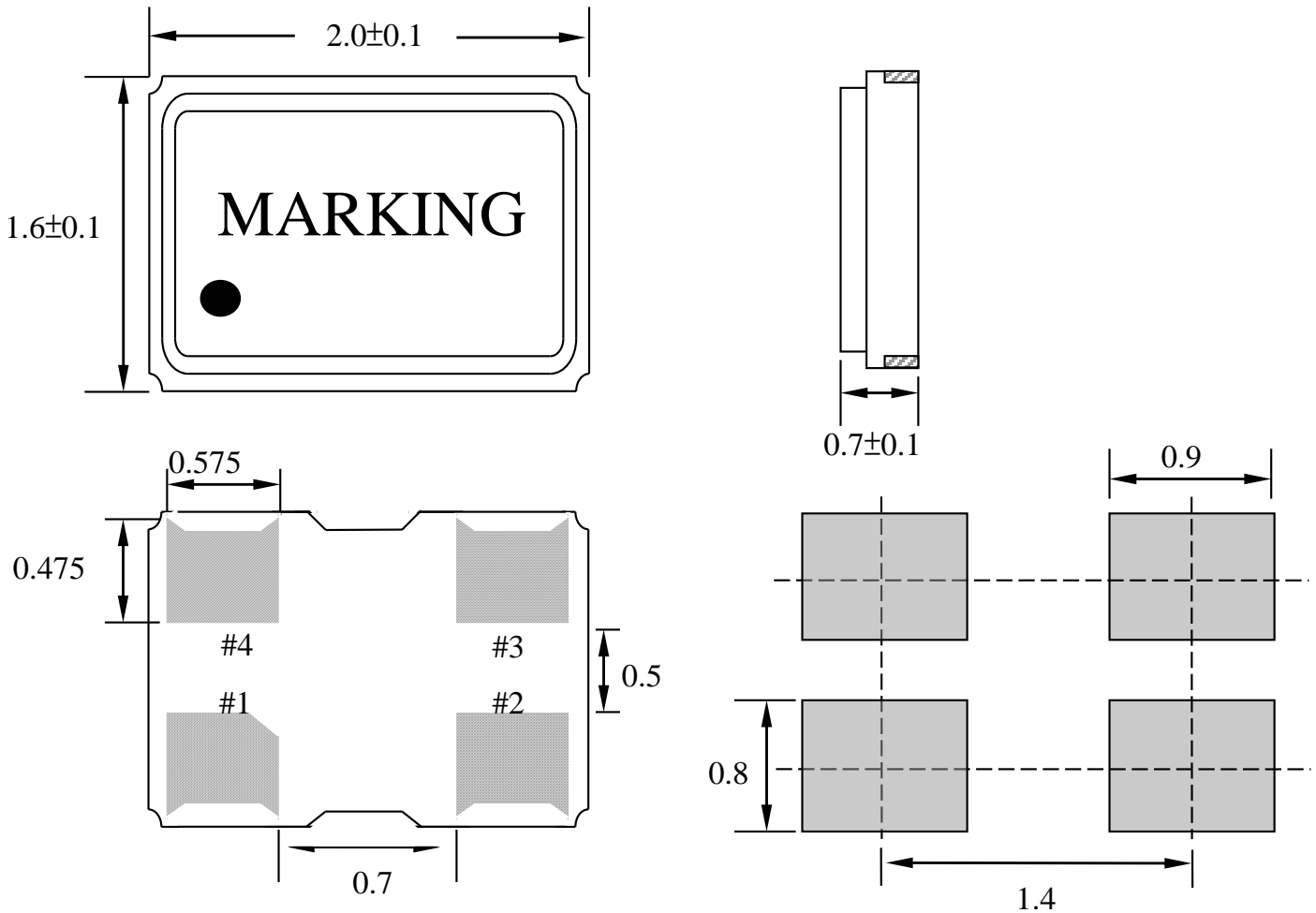

| Pin | Connections |
|------------|-------------|
| #1: Vcon | #2: Gnd |
| #3: Output | #4: Vdd |

* Above specification subject to change without prior notice, please consult our sales representative for more information*

TAIWAN — JENJAAN QUARTEK CORPORATION

Address : 3F-5, No 504 Yun Shan Road, Chung Ho City, Taipei, Taiwan
 Tel : +886-2-8221-4498 Fax : +886-2-8221-4499
 E-mail : jenjaan@jenjaan.com.tw Web : http://www.nsk.com.tw

FACTORY - DONG GUAN ALLIED PROJECT LIMITED

Address : No. 703, Fu Min Zhong Road, Yang Yong Village, Dalang
 Town, Dong Guan, Guang Dong, China Tel : +86-769-8311-9395
 Fax : +86-769-8313-0880 E-mail : alliedj@pub.dgnet.gd.cn

Tape Specification(mm) :

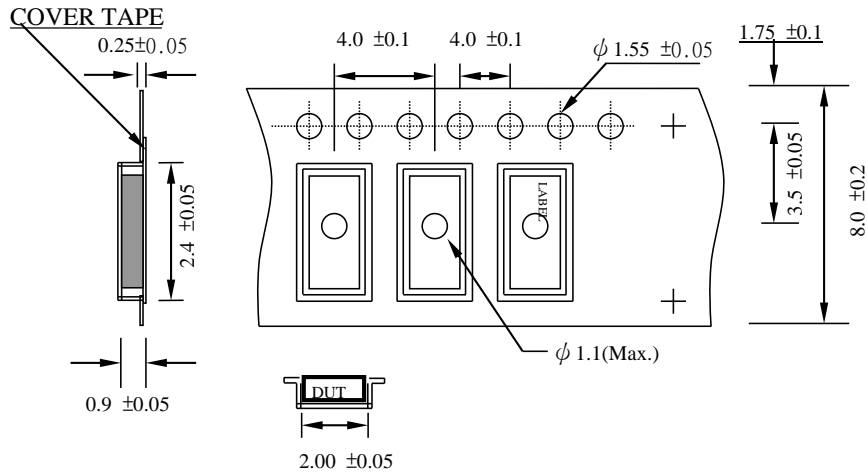

Reel Packing(mm) :

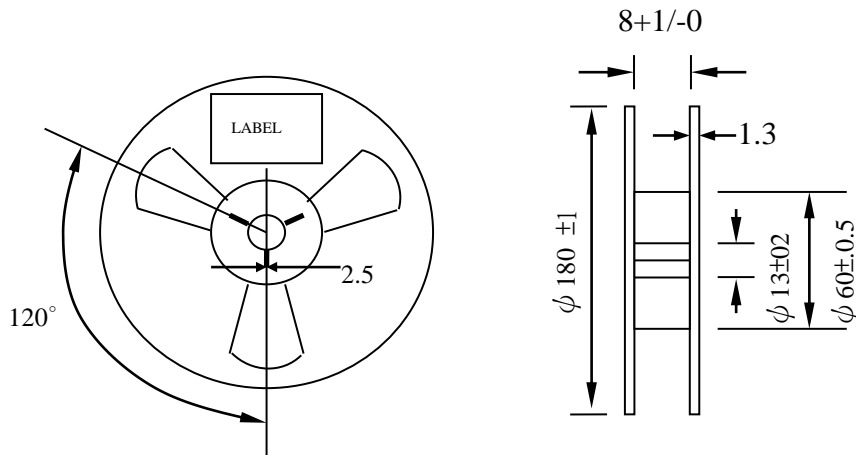

Reflow Temperature Profile :

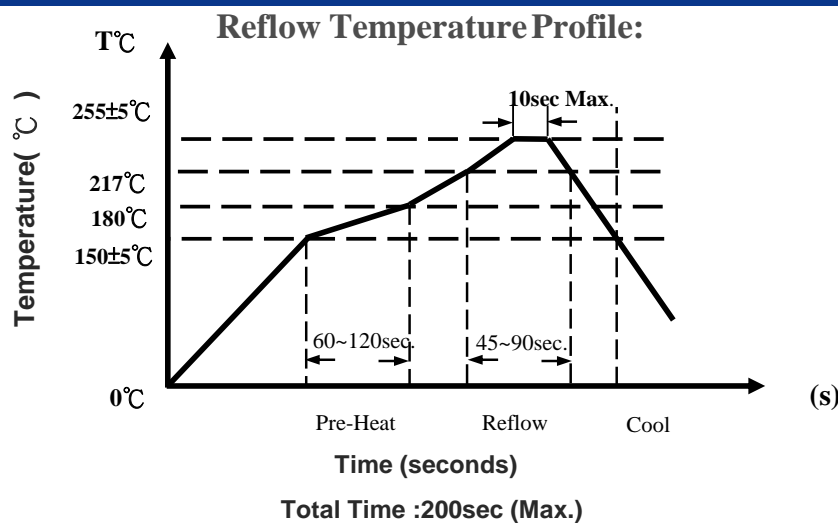

* Above specification subject to change without prior notice, please consult our sales representative for more information*

TAIWAN — JENJAAN QUARTEK CORPORATION

Address : 3F-5, No 504 Yun Shan Road, Chung Ho City, Taipei, Taiwan

Tel : +886-2-8221-4498

E-mail : jenjaan@jenjaan.com.tw

Fax : +886-2-8221-4499

Web : <http://www.nsk.com.tw>

FACTORY - DONG GUAN ALLIED PROJECT LIMITED

Address : No. 703, Fu Min Zhong Road, Yang Yong Village, Dalang

Town, Dong Guan, Guang Dong, China Tel : +86-769-8311-9395

Fax : +86-769-8313-0880

E-mail : alliedj@pub.dgnet.gd.cn