

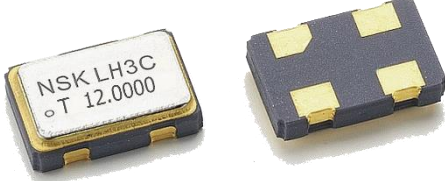













## NATH Series 5.0 x 3.2

  	<b>TCXO Application :</b>
	<ul style="list-style-type: none"> <li> Communications</li> <li> Smartphone</li> <li> WiMAX</li> <li> GPS</li> </ul>
	<b>Features :</b>
	<ul style="list-style-type: none"> <li> Excellent environmental capability</li> <li> Supply voltage: 1.8V ~ 3.3V</li> <li> RoHS compliant / Pb free</li> <li> Low power consumption</li> <li> Seam welding</li> </ul>



## Electrical Specification :

Model		NATH-53
Frequency Range	MHz	12.0 ~ 60.0
Supply Voltage	V	1.8 ~ 3.3
Frequency Stability	PPM max	±2.0 (After 2 times reflows)
Operating Temperature Range	°C	-30 ~ +85 or specify
Storage Temperature Range	°C	-55 ~ +125
Current	mA max	2.5
Output Load		10KΩ // 10pF
Output Level	Vp-p min	0.8
Start-up Time	mS max	5
Rise and Fall Time	nS max	5
Phase Noise (10kHz offset)	dBc / Hz Typ.	-148
Aging	PPM / year	±1

**\* Above specification subject to change without prior notice, please consult our sales representative for more information\***

### TAIWAN — JENJAAN QUARTEK CORPORATION

Address : 3F-5, No 504 Yun Shan Road, Chung Ho City, Taipei, Taiwan  
 Tel : +886-2-8221-4498 Fax : +886-2-8221-4499  
 E-mail : jjenjaan@jenjaan.com.tw Web : http://www.nsk.com.tw

### FACTORY - DONG GUAN ALLIED PROJECT LIMITED

Address : No. 703, Fu Min Zhong Road, Yang Yong Village, Dalang  
 Town, Dong Guan, Guang Dong, China Tel : +86-769-8311-9395  
 Fax : +86-769-8313-0880 E-mail : alliedj@pub.dgnet.gd.cn

## Dimensions (mm) :

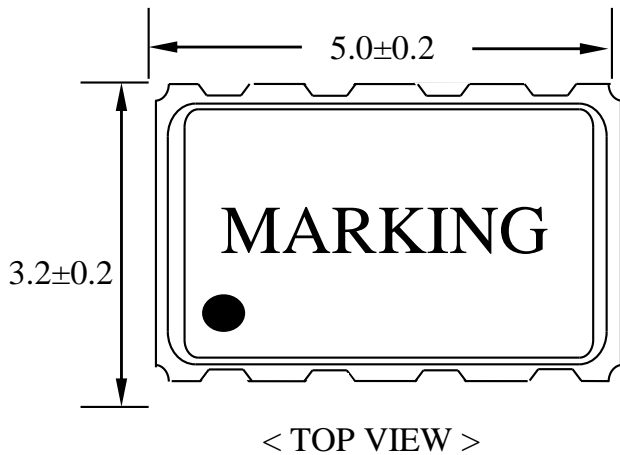

< TOP VIEW >

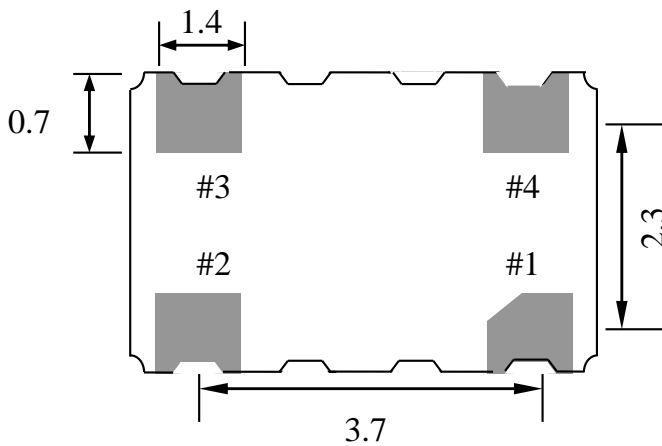
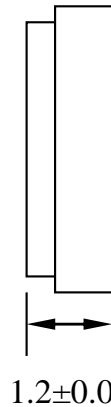

< TOP VIEW >

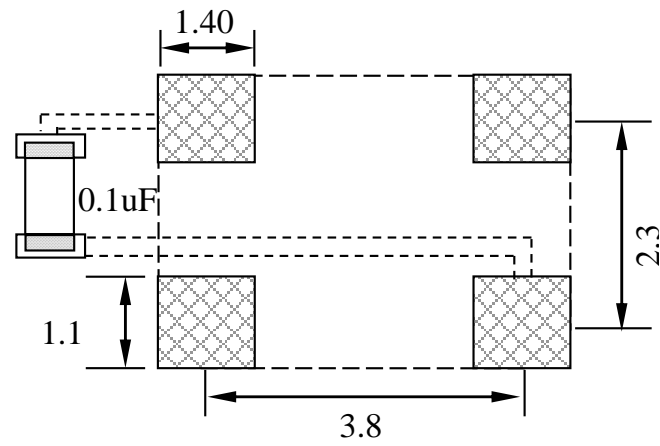

(Recommended Land Pattern)

Pin	Connections
#1: Vcon	#2: Gnd
#3: Output	#4: Vdd

\* Above specification subject to change without prior notice, please consult our sales representative for more information\*

TAIWAN — JENJAAN QUARTEK CORPORATION

Address : 3F-5, No 504 Yun Shan Road, Chung Ho City, Taipei, Taiwan

Tel : +886-2-8221-4498

Fax : +886-2-8221-4499

E-mail : jenjaan@jenjaan.com.tw

Web : <http://www.nsk.com.tw>

FACTORY - DONG GUAN ALLIED PROJECT LIMITED

Address : No. 703, Fu Min Zhong Road, Yang Yong Village, Dalang

Town, Dong Guan, Guang Dong, China Tel : +86-769-8311-9395

Fax : +86-769-8313-0880

E-mail : [alliedj@pub.dgnet.gd.cn](mailto:alliedj@pub.dgnet.gd.cn)

## Tape Specification(mm) :

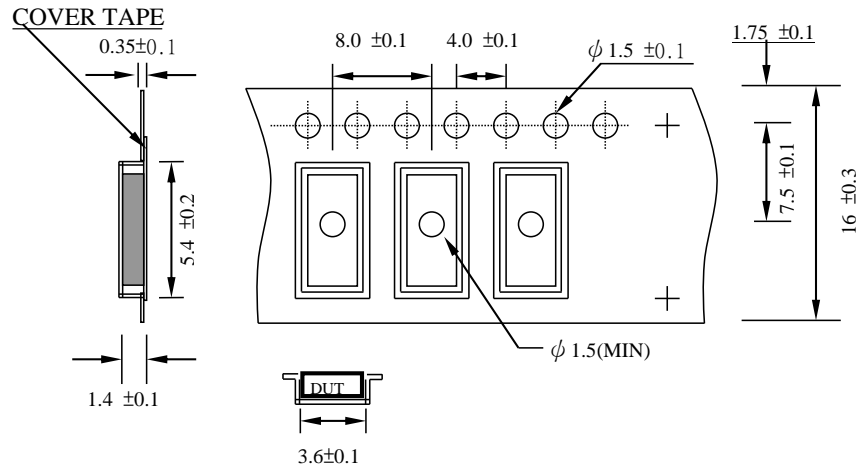

## Reel Packing(mm) :

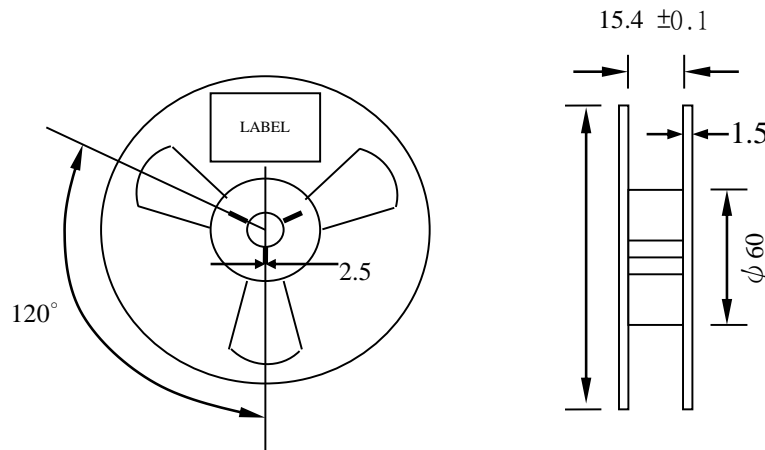

## Reflow Temperature Profile :

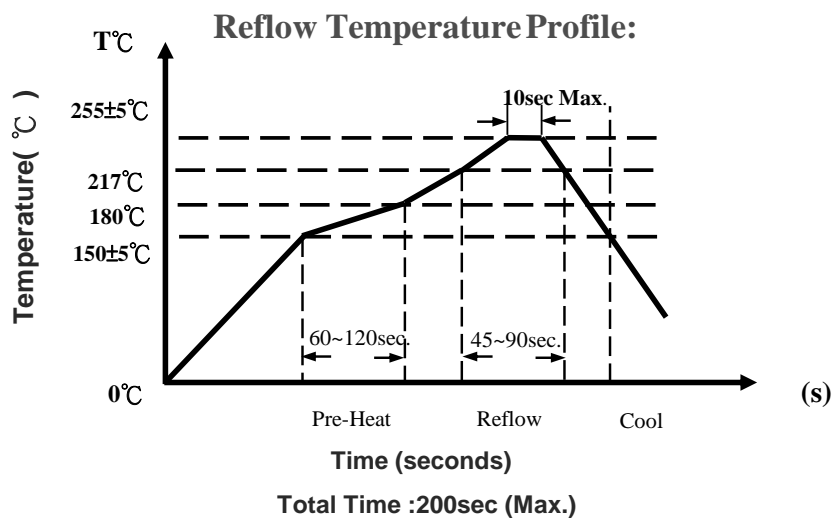

\* Above specification subject to change without prior notice, please consult our sales representative for more information\*

TAIWAN — JENJAAN QUARTEK CORPORATION

Address : 3F-5, No 504 Yun Shan Road, Chung Ho City, Taipei, Taiwan

Tel : +886-2-8221-4498

E-mail : jenjaan@jenjaan.com.tw

Fax : +886-2-8221-4499

Web : <http://www.nsk.com.tw>

FACTORY - DONG GUAN ALLIED PROJECT LIMITED

Address : No. 703, Fu Min Zhong Road, Yang Yong Village, Dalang

Town, Dong Guan, Guang Dong, China Tel : +86-769-8311-9395

Fax : +86-769-8313-0880

E-mail : alliedj@pub.dgnet.gd.cn