

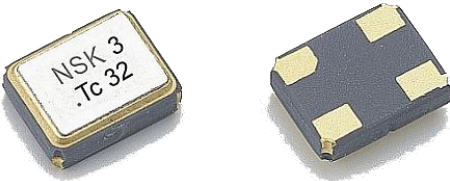













NATL Series 2.5 x 2.0

  	TCXO Application : <ul style="list-style-type: none">  Communications  Smartphone  WiMAX  GPS
	Features : <ul style="list-style-type: none">  Excellent environmental capability  Supply voltage: 1.8V ~ 3.3V  RoHS compliant / Pb free  Low power consumption  Seam welding



Electrical Specification :

Model		NATL-22
Frequency Range	MHz	12.0 ~ 60.0
Supply Voltage	V	1.8 ~ 3.3
Frequency Stability	PPM max	±2.0 (After 2 times reflows)
Operating Temperature Range	°C	-30 ~ +85 or specify
Storage Temperature Range	°C	-55 ~ +125
Current	mA max	2.5
Output Load		10KΩ // 10pF
Output Level	Vp-p min	0.8
Start-up Time	mS max	5
Rise and Fall Time	nS max	5
Phase Noise (10kHz offset)	dBc / Hz Typ.	-148
Aging	PPM / year	±1

*** Above specification subject to change without prior notice, please consult our sales representative for more information***

TAIWAN — JENJAAN QUARTEK CORPORATION

Address : 3F-5, No 504 Yun Shan Road, Chung Ho City, Taipei, Taiwan
 Tel : +886-2-8221-4498 Fax : +886-2-8221-4499
 E-mail : jjenjaan@jenjaan.com.tw Web : http://www.nsk.com.tw

FACTORY - DONG GUAN ALLIED PROJECT LIMITED

Address : No. 703, Fu Min Zhong Road, Yang Yong Village, Dalang
 Town, Dong Guan, Guang Dong, China Tel : +86-769-8311-9395
 Fax : +86-769-8313-0880 E-mail : alliedj@pub.dgnet.gd.cn

Dimensions (mm) :

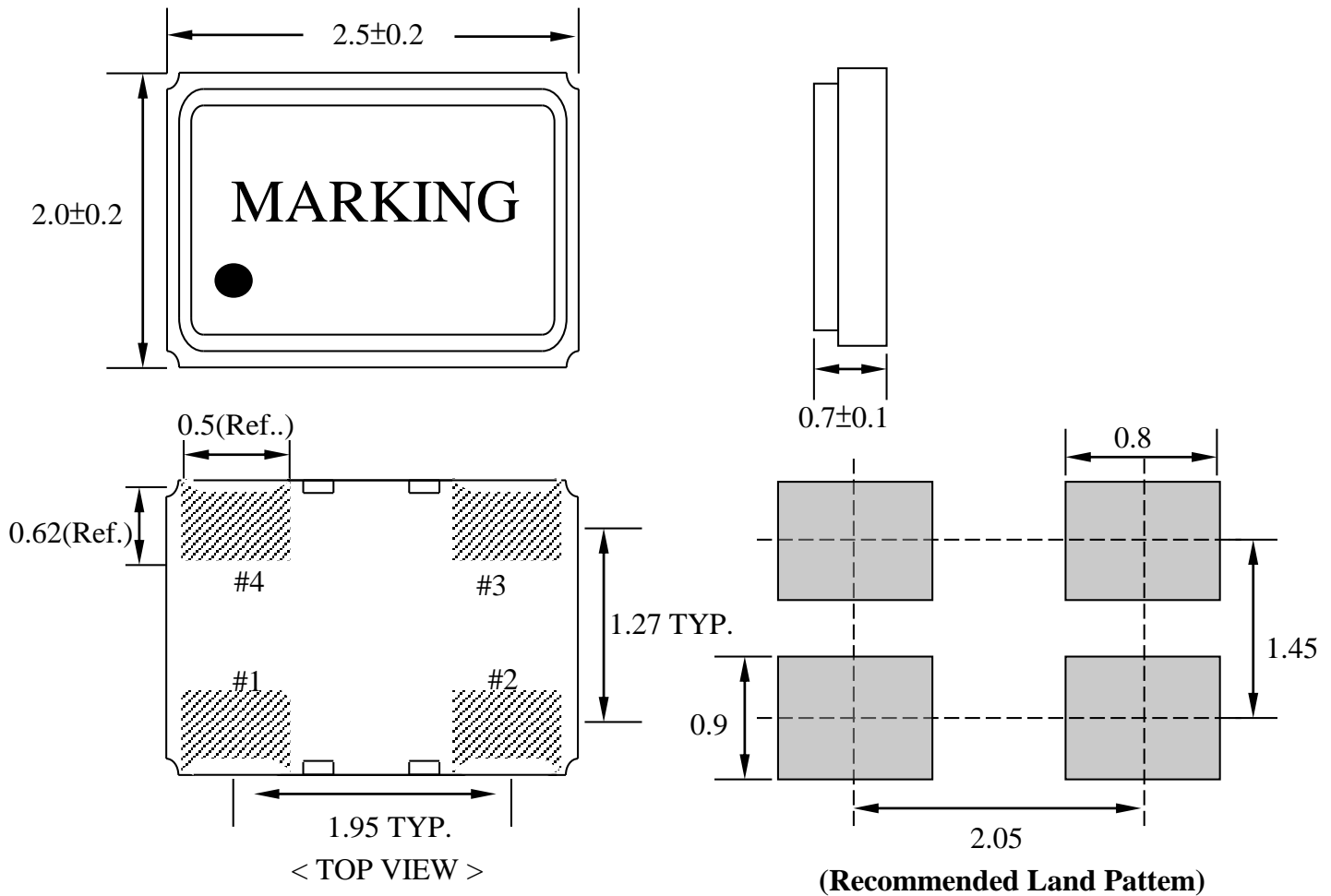

Pin	Connections
#1: Vcon	#2: Gnd
#3: Output	#4: Vdd

* Above specification subject to change without prior notice, please consult our sales representative for more information*

TAIWAN — JENJAAN QUARTEK CORPORATION

Address : 3F-5, No 504 Yun Shan Road, Chung Ho City, Taipei, Taiwan
 Tel : +886-2-8221-4498 Fax : +886-2-8221-4499
 E-mail : jenjaan@jenjaan.com.tw Web : http://www.nsk.com.tw

FACTORY - DONG GUAN ALLIED PROJECT LIMITED

Address : No. 703, Fu Min Zhong Road, Yang Yong Village, Dalang
 Town, Dong Guan, Guang Dong, China Tel : +86-769-8311-9395
 Fax : +86-769-8313-0880 E-mail : alliedj@pub.dgnet.gd.cn

Tape Specification(mm) :

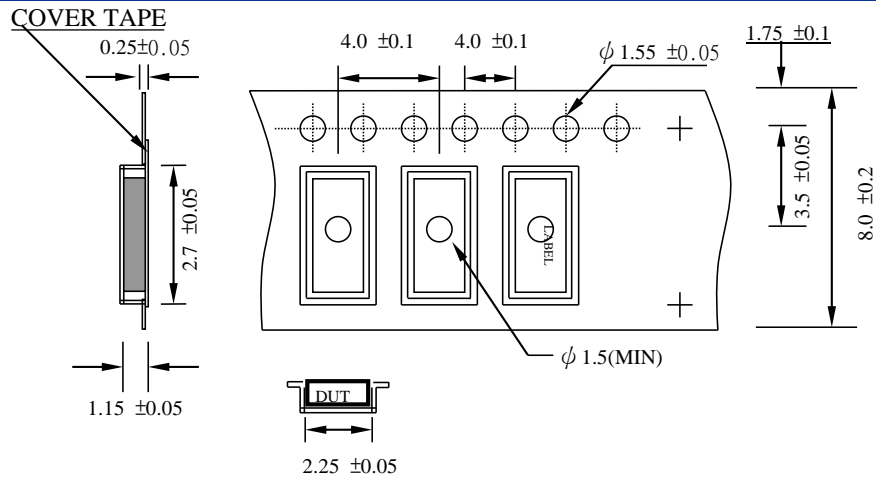

Reel Packing(mm) :

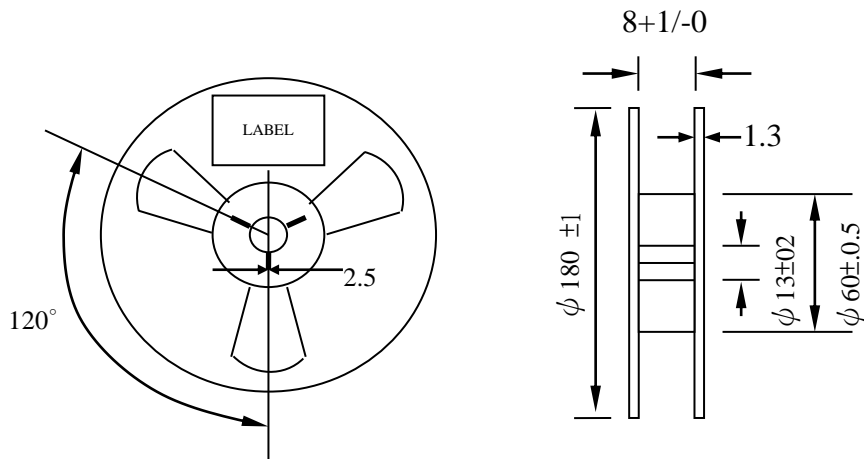

Reflow Temperature Profile :

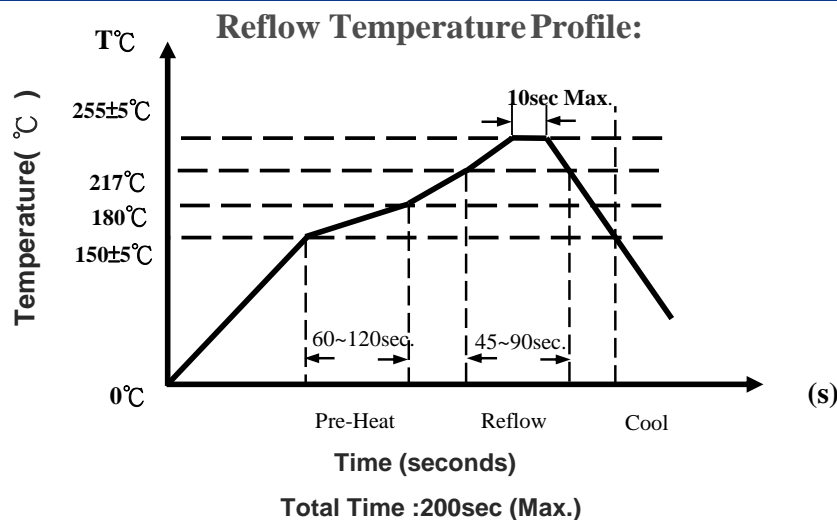

* Above specification subject to change without prior notice, please consult our sales representative for more information*

TAIWAN — JENJAAN QUARTEK CORPORATION

Address : 3F-5, No 504 Yun Shan Road, Chung Ho City, Taipei, Taiwan

Tel : +886-2-8221-4498

E-mail : jenjaan@jenjaan.com.tw

Fax : +886-2-8221-4499

Web : <http://www.nsk.com.tw>

FACTORY - DONG GUAN ALLIED PROJECT LIMITED

Address : No. 703, Fu Min Zhong Road, Yang Yong Village, Dalang

Town, Dong Guan, Guang Dong, China Tel : +86-769-8311-9395

Fax : +86-769-8313-0880

E-mail : alliedj@pub.dgnet.gd.cn